

NOTE: 1) HYDRO @ 240 PSIG. MIN.  
 2) 4-1-04 PROOF TEST.

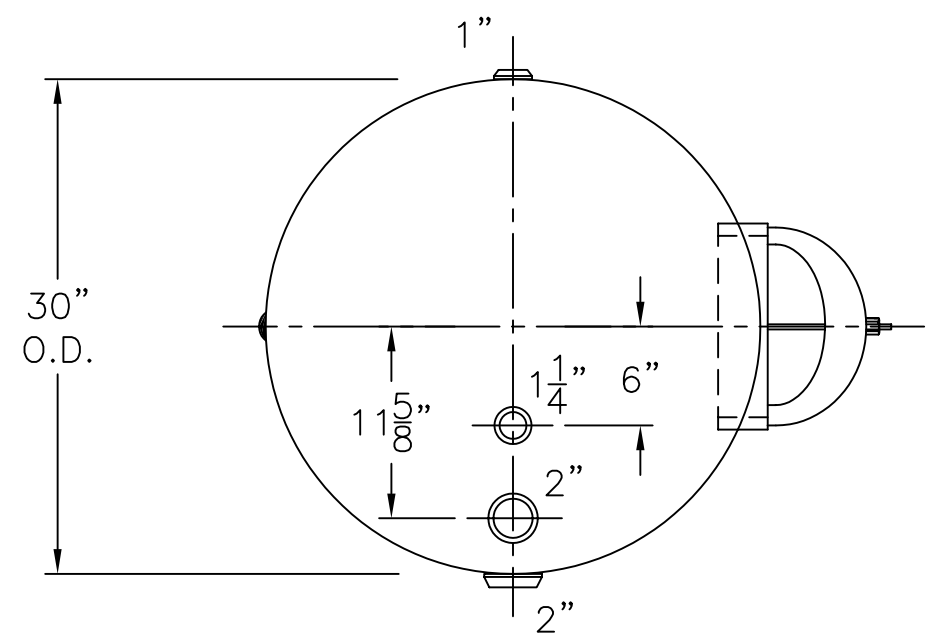

VIEW W/OUT SUPPORTS

HEADS	.166" SA-414-G 2:1 S.E.	ES-30-250-H	REV. 9-14-04
	JOGGLE		DATE: 4-3-03
SHELL	.165" SA-414-G	FOR: HANSON STANDARD	
		HORIZ. HOT WATER TANK	
		SURFACE AREA = 61.3 SQ. FT.	
M.A.W.P. 160 PSIG. @ 180 °F		INSIDE: EPOXY LINED	
ASME. SECTION IV 2001 ADD 2003		OUTSIDE: PRIME	
X-RAY: RT-NO / H.L.W.		CAD-"B" UNDER "STD"-SERIES	
GALLONS: 250 WT. 512 LBS.		BY: E.S.	SCALE: 1"=12"
SERIAL NO.		<b>ROY E. HANSON JR. MFG.</b>	
N.B.		1924 COMPTON AVE. LOS ANGELES, CA 90011	